

D Bedienungsanleitung

GB Installation instructions

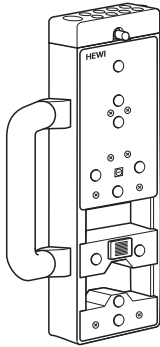

**Bohrlehre
Installation jig**

1

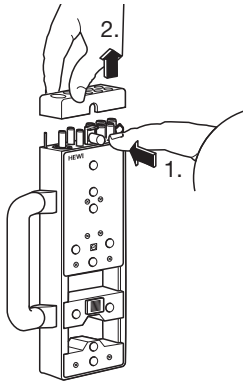

2

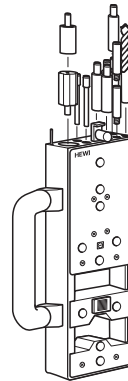

ø 22 mm KABA (Schweiz | Switzerland)



ø 17 mm Profilylinder (PZ) | Euro cylinder



ø 10 mm Zentrierdorn | centering pin



ø 9 mm Zentrierdorn | centering pin



ø 8,5 mm Zentrierdorn | centering pin
(Österreich | Austria)



ø 8 mm Zentrierdorn | centering pin



ø 8 mm Zentrierdorn | centering pin



ø 7 mm geteilter Zentrierdorn, auch als
Verlängerung nutzbar | split centering
pin, also usable as extension



ø 6 mm Zentrierdorn | centering pin



ø 5 mm Zentrierdorn | centering pin



Bohrer | drill bit

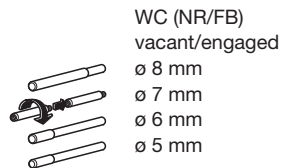
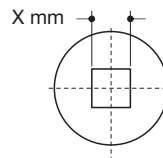
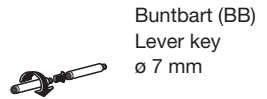
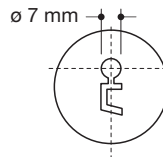
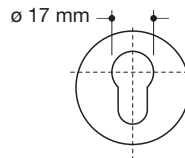
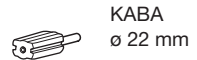
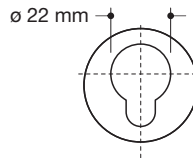
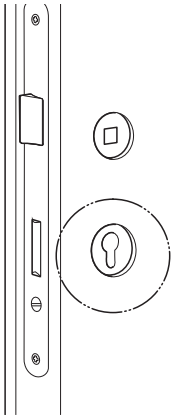
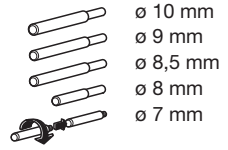
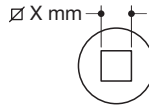
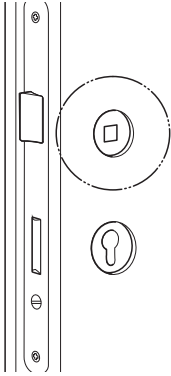

1

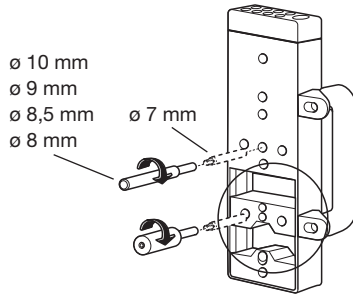

2a

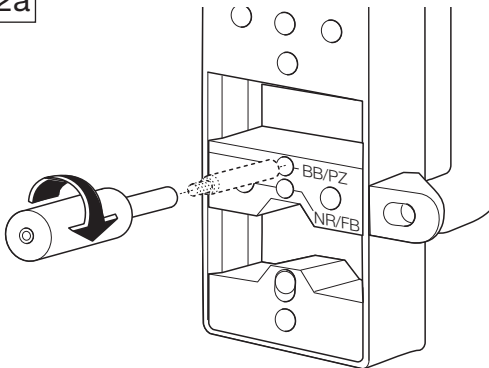

- Buntbart (BB)
Lever key
- Profilzylinder (PZ)
Euro cylinder
- KABA

2b

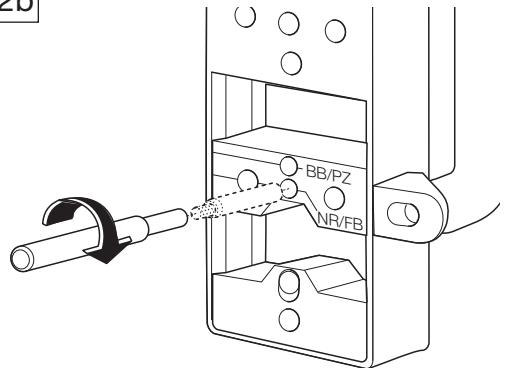

- WC (NR/FB)
vacant/engaged

1

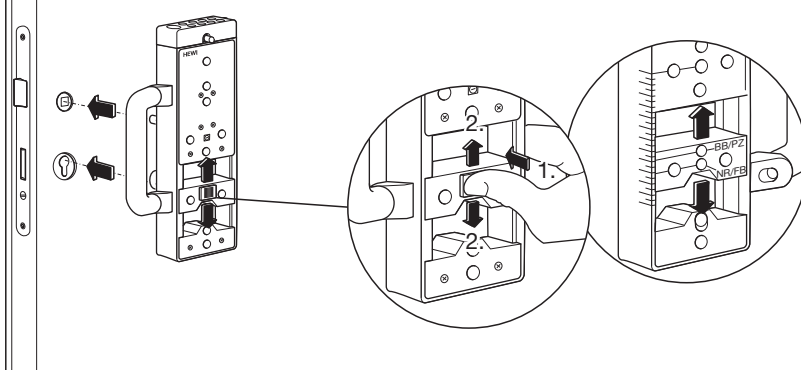

2

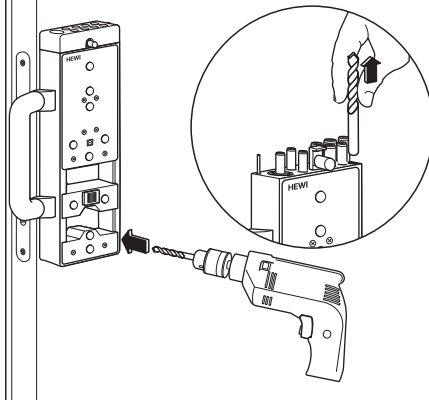

3

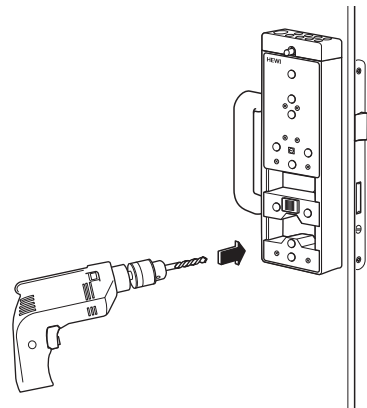

 Achtung!

Nicht in oder durch den Schlosskasten bohren!



 Very important to note!

Do not drill into or through the lockcase!



Rosette

roses

- 305...
- 306...
- 307...
- 308...

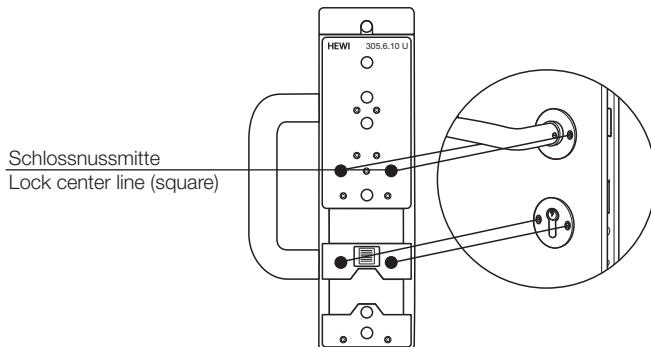

Schild

backplate

- 217...R
- 230...R 230...H
- 285...R

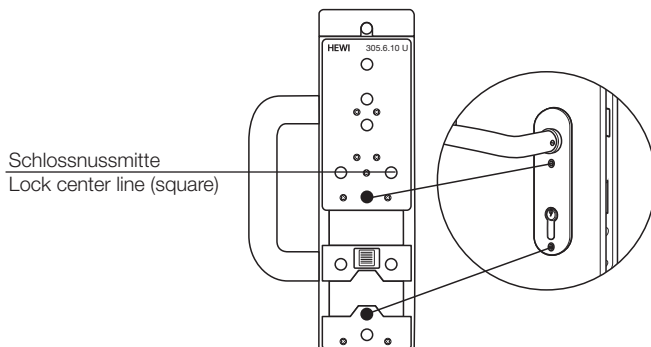

Schutzbeschlag (Kurzschild)

Security backplate (short)

- ...ES1

mit Bohrer \varnothing 10,5 mm nachbohren.
redrill with drill bit \varnothing 10,5 mm.

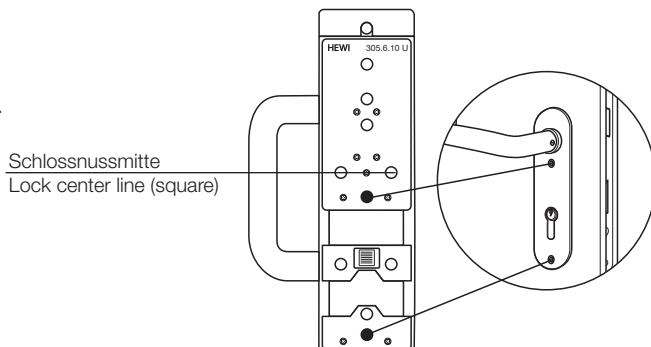

**Schild
backplate**
230...E

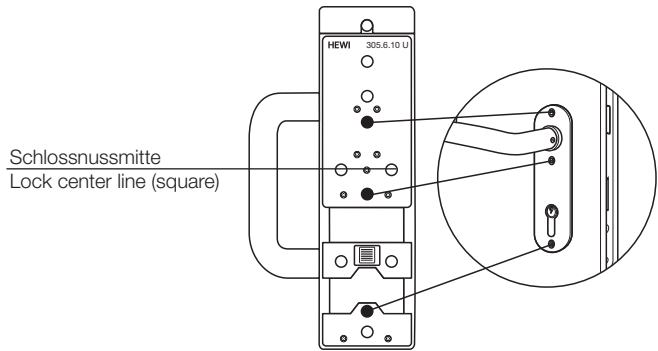

**Schild
backplate**
235...R 219...H
220...H
235...H
236...H

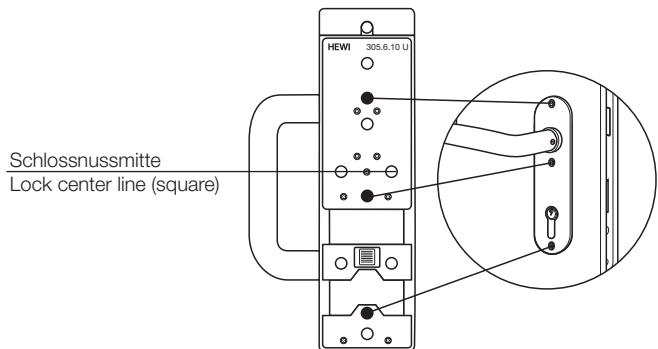

Schutzbeschlag (Langschild)
Security backplate (long)
...ES3

mit Bohrer \varnothing 10,5 mm nachbohren.
redrill with drill bit \varnothing 10,5 mm.

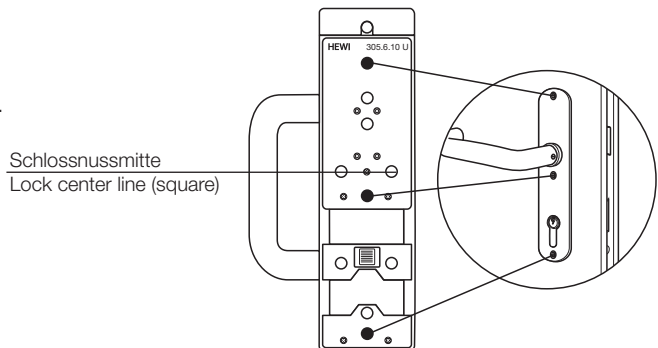

HEWI

www.hewi.com

Deutschland

HEWI Heinrich Wilke GmbH

Postfach 1260

D-34442 Bad Arolsen

Telefon: +49 5691 82-0

Telefax: +49 5691 82-319

info@hewi.de